

Article number: 09065514

Description: KLEE Feather keys B 5x5x14 DIN 6885

Measures

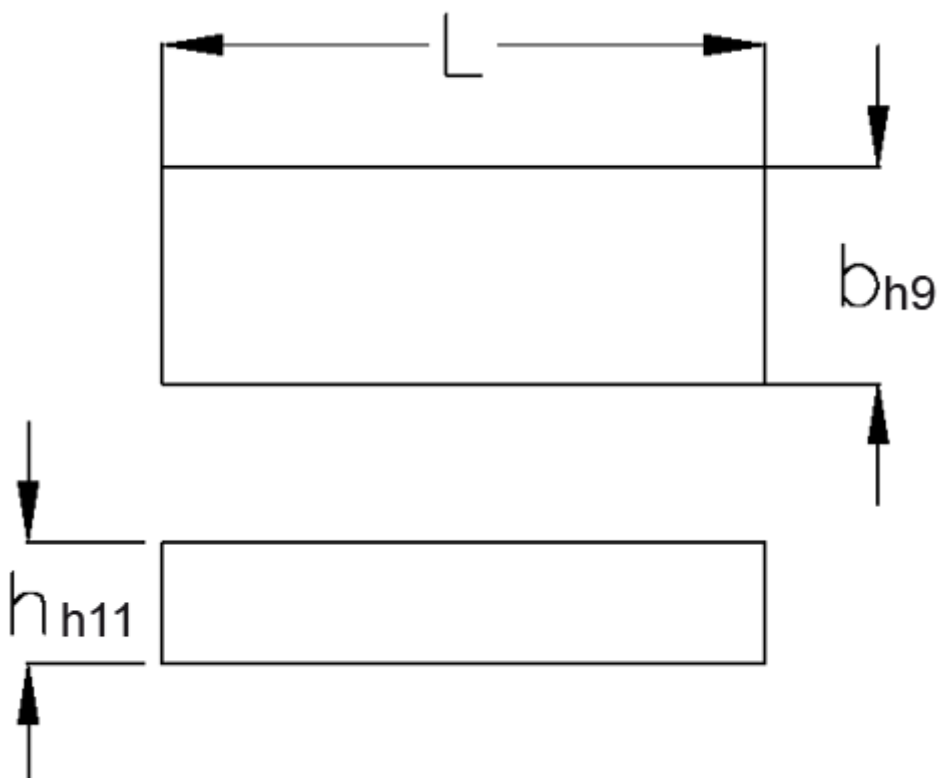

b	= 5
h	= 5
L	= 14
Tolerance b	= 0.030
Tolerance h	= 0.075
Tolerance L	= -0,2